



# X450

## 快速入门手册

### Instruction Manual



[www.xk-innovations.com](http://www.xk-innovations.com)

## Product introduction 产品简介

Thank you for purchasing the Vertical Flight Multi-Function Fixed Wing. It uses three 1307 brushless motors, two high-precision 5g digital servos, two 4.3g digital servos, and a 6-axis gyroscope (compatible with 3-axis gyroscopes). the flying machine adopts the delta wing layout, the air resistance is small, the time is long, and the power is strong. The vertical take-off and landing fixed wing effectively solves the problem of insufficient flight space. It can take off vertically anywhere. It also has multiple flight modes Multirotor flight mode, which is very easy to fly, just like flying a quadcopter. 6G's plane flight mode, 6G horizontal flight has a fixed height self-stabilization mode, which is very suitable for beginners to practice, regardless of the state of the aircraft, release the rocker aircraft can resume smooth flight. 3D stabilized flight mode, you can make a variety of special effects like the master, after releasing the remote control joystick, the aircraft will lock the current flight attitude very well. Vertical flight Vertical mode, you can fly like a F3P master, and have a barometer to set the height and stability.

感谢你购买Vertical flight 垂直起降多功能固定翼，该机采用三个1307无刷电机，2个高精度5g数字舵机 2个4.3g数字舵机，并使用6轴陀螺仪（兼容3轴陀螺仪），该机采用三角翼布局，空气阻力小，留空时间长，动力强劲。Vertical flight 垂直起降固定翼有效解决飞行场地不足的问题，任何地方都可以垂直起飞，而且它还具有多种飞行模式多旋翼模式飞行模式Multirotor flight，非常容易飞行，就像飞四轴飞行器一样容易6G的平飞模式Airplane flight，6G水平飞行具有定高自稳模式，非常适合初学者练习，无论飞机在什么状态，松开摇杆飞机就恢复平稳飞行。3D增稳飞行模式，你可以像高手一样做出各种特技动作，松开遥控器摇杆后，飞机会很好锁定当前飞行姿态。Vertical flight 垂直模式，你可以像F3P高手一样吊机飞行，并有气压计定高增稳。

## Features 产品特点

1. Vertical take-off and landing with fixed height function One-button take-off/landing, multi-rotor flight mode Multirotor flight, easy to operate, suitable for indoor and outdoor flight.
2. Outdoor one-button conversion 6G level flight mode with 6G auto-stabilization and 3D trick mode
3. air free switching, one-button crane mode, this mode has a barometer fixed high self-stability,
4. The aircraft is made of engineering plastic and EPO material, and the carbon fiber rod is built in the wing to reinforce.
5. uses three 1307 brushless motors for powerful power.
6. high-rate large-capacity lithium polymer battery, flight time is about 12 minutes or more
7. 2 high-precision 5g digital servo and 2 4.3g servo, correspondingly fast and stable.
8. Reserve the front camera lens bin to load 5G 720P WIFI image transmission.

1. 垂直起降固定翼具有定高功能 一键起飞/降落，多旋翼模式飞行模式Multirotor flight，操作简单，适合室内室外飞行。
2. 室外一键转换6G平飞模式，具有6G自稳和3D特技模式
3. 空中自由切换，一键吊机模式，该模式具有气压计定高自稳，
4. 飞机采用工程塑胶及EPO材质，机翼内置碳纤维杆补强。
5. 采用三颗1307无刷电机，动力强劲。
6. 高倍率大容量锂聚合物电池，飞行时间大约12分钟以上
7. 2颗高精度5g数字舵机及2颗4.3g舵机，相应迅速稳定。
8. 预留前置摄像头仓，可加载5G 720P WIFI图传。

## Packing list 包装清单

No. 序号	Name 名称	Quantity 数量	No. 序号	Name 名称	Quantity 数量
1	Color box 彩盒	1	5	Charger + adapter 充电器+适配器	1
2	Styrofoam packing box 保利龙包装盒	1	6	Left and right vertical tail 左右垂直尾翼	1
3	Instruction 说明书	1	7	remote control 遥控器	1
4	11.1v 1000mah lithium polymer battery 11.1v 1000mah 锂聚合物电池	1	8	Forward / reverse paddle 正/反转桨叶	1

## Product parameters 产品参数

Product Item: X450

Material: EPO

Product Description: Vertical takeoff and landing aircraft

Product Size: 450 \* 444.5 \* 107

Flight weight: 275g

Motor: 1307 2300KV

Servo: 4.3g metal steering gear

Flight time: 12 minutes

产品货号: X450

材质: EPO

产品描述: 垂直起降飞行器

产品尺寸: 450\*444.5\*107

飞行重量: 275g

马达: 1307 2300KV

舵机: 4.3g 金属舵机

飞行时间: 12分钟

## Remote control function indication 遥控器功能指示

Multicopter flight

Airplane flight

Veretlic flight

开关上 多旋翼飞行模式

开关中 水平飞行6G模式

开关下 垂直飞行吊机模式

Direction joysticker (front and rear  
left and right side fly)

方向摇杆

(前后左右侧飞)

Control joystick  
(throttle steering)

控制摇杆 (油门转向)

6G/3D mode  
conversion  
6G/3D模式转换

Button to switch MO  
DE1 / MODE2  
conversion After  
switching the rudder  
volume

按键开机MODE1/MODE2  
转换开机后舵量转换

Long press: one key  
take-off/one key landing  
长按一键起飞/一键降落

Press STUCK MODE and PHOTO at the  
same time motor emergency stop  
同时按STUCK MODE与PHOTO键马达急停

Short press: Photo;  
Long press: take video  
短按拍照/长按摄像

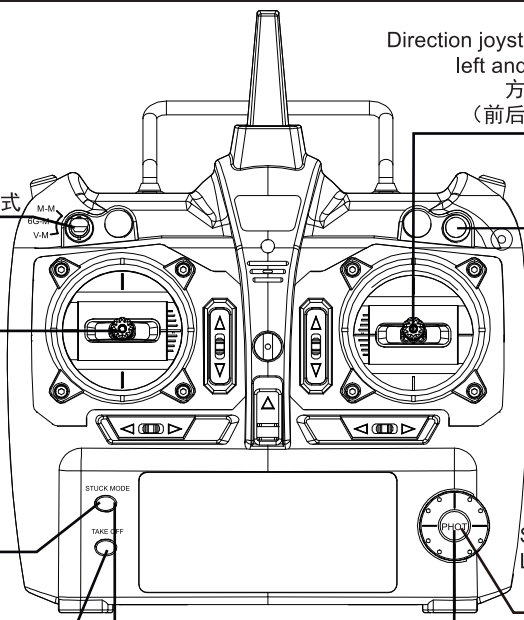

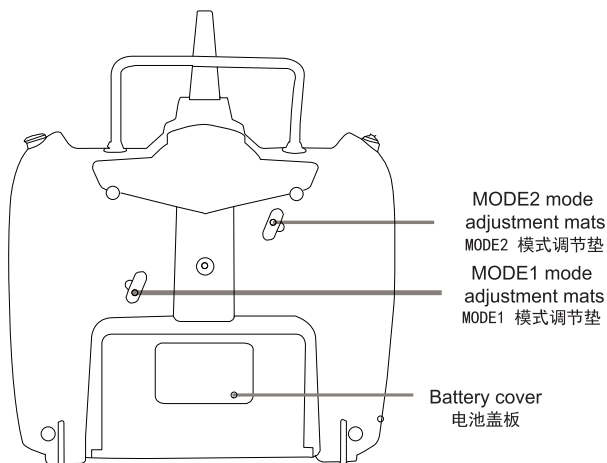

## Remote control MODE1 and MODE2 conversion 遥控器MODE1与MODE2转换

Open the remote control directly for the current mode (MODE1 or MODE2)

- 1) Firstly, press the STICK MODE button, at the same time turn on the remote control to change the mode.
- 2) Open the rubber which is located in the back cover of remote control.
- 3) Using a Phillips screwdriver, loosen the current throttle plate and relax the current damping plate to make the feel lighter and reduce the damping. And then to be used as a throttle rocker pressing plate locking, rocker lever separated from the spring, and adjust the damping plate according to personal feel.
- 4) After completing the above actions, turn off the remote control, turn on the remote control again, and bind with the plane.

直接打开遥控器为当前模式（MODE1或者MODE2），

- 1) 首先按STICK MODE同时打开遥控器，进行模式转换
- 2) 打开遥控器后盖上面的橡胶盖
- 3) 使用十字螺丝刀放开当前油门压制板，同时放松当前阻尼板使手感变轻，减小阻尼。再要把作为油门摇杆的压制板锁紧，隔开弹簧放松摇杆，并根据个人手感调整阻尼板。
- 4) 完成以上动作后关闭遥控器，再次打开遥控器和飞行器进行对频。

Spring press plate  
弹簧压制板

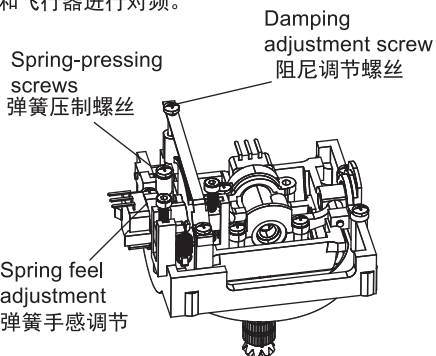
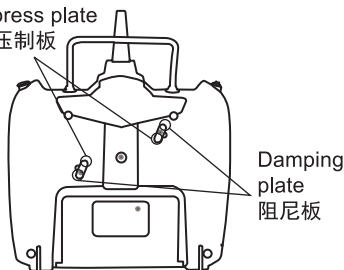



## Charging 电池充电

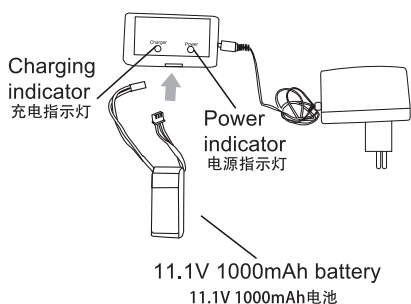

1. Connect power adapter with lipo charger.
2. Insert the connected charger into the AC outlet, then power indicator lights always on (green)
3. Insert the battery into the charger, the charge indicator (red) lights always on. Red lights extinguish when charging completed.

1. 将电源适配器与Lipo充电器进行连接。
2. 再将连接好的充电器插入AC插座，此时Lipo电器的电源指示灯（绿灯）长亮。
3. 将电池插头插入充电器内，充电指示灯（红）长亮，电池饱和后红灯灭。

### Warning:

#### 警告：

1. To ensure safety, please charge under guardianship.
2. Children can not charge alone, should charge in adult assistance.
3. Use the product original standard charger, if using charger of unknown origin that may occur burning or explosion.

1. 为了确保安全，请在有人监护下进行充电。
2. 儿童不可独自进行充电，要在成人协助下进行充电。
3. 请使用本产品原装标配充电器进行充电，使用来历不明的充电器可能发生燃烧爆炸事故。

## Charging 螺旋桨安装方向

Install the left and right wings into the fixing slots and fix them with 1.7x6PB screws.  
请严格按照图示安装更换螺旋桨，错误安装将导致无法飞行

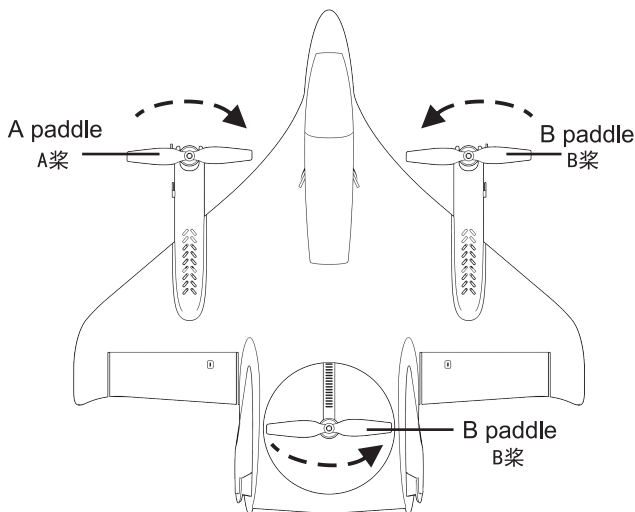

## Install left and right vertical tail 安装电池

Open the battery compartment cover and insert the battery to ensure that the battery plug is properly connected.

Special tips: 1. Make sure the battery is saturated before flying.

2. Be sure to disconnect the plug and remove the battery every time after flight.

打开电池仓罩装入电池，确保电池插头正确连接 扣上仓盖后进入对频飞行。

特别提示：1. 飞行前要确保电池是饱和状态。

2. 每次飞行完成请务必断开插头连接并取出电池，以免对飞。

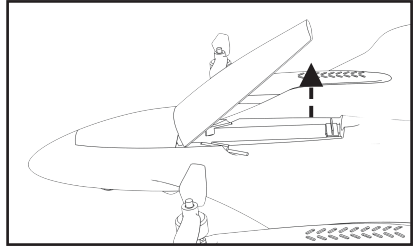
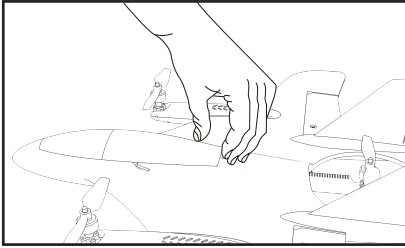

## Install left and right vertical tail 安装左右垂直尾翼

Install the left and right wings into the fixing slots and fix them with 1.7x6PB screws.

分别将左右机翼装入固定槽内，并用1.7x6PB螺丝进行固定。

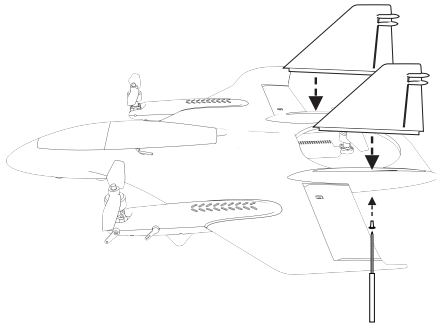

## Rudder adjustment on the plane 飞行器舵面调节

1. Connect the power. If the rudder surface is not in the middle position, adjust the rudder surface to the middle position by manually rotating the active joint.
2. The adjusted aircraft motor cannot be started and the gyroscope should be turned off. The gyroscope cannot accurately adjust the rudder surface to the middle position in the repair state.
3. Rotating the wire to the right can shorten the length of the push-pull wire, and rotating to the left can lengthen the length of the push-pull wire.

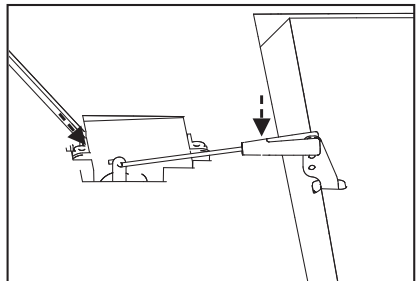

1. 给飞机上电，应该回中，如果舵面不在中间位置，通过手动旋转活络接头将舵面调整到中间位置。
2. 调整的飞机马达不能被启动过，陀螺仪要处于关闭状态。陀螺仪在修复状态下不能准确的将舵面调整到中间位置。
3. 钢丝向右旋转可减短推拉钢丝长度，向左旋可加长推拉钢丝长度。

## Binding 遥控器与飞行器对频

- 1 Make sure the throttle stick is in the lowest position, turn on the remote control, the remote control will make a long "DI" sound prompt to turn on the power, and the power indicator of the remote control will flash, prompting not to receive the frequency
- 2 lonnect the power, the receiver indicator light flashing, dial the throttle stick to the top, and then pulled to the bottom, the remote control sound "DI", the power light is keep on, the receiver lights keep on, Frequency complete.
- 3 If the frequency is not successful, you need to disconnect the aircraft power and turn off the remote control, repeat the above frequency steps again.

- 1 确保油门摇杆在最下位置，档位开关在最上位置，打开遥控器，遥控器发出一声长滴滴音提示开机，此时遥控器电源指示灯闪烁，提示未与接收对频
- 2 给飞行器上电，接收机指示灯闪烁，拨动油门摇杆到最上，然后拉到最下，遥控器发出一声滴音，电源指示灯常亮，接收机灯也恢复常亮，提示对频完成。
- 3 如对频不成功，需断开飞行器电源及关闭遥控器，再次重复上述对频步骤。

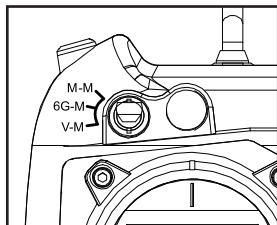

## First flight command 首次飞行指挥

1. Multi-rotor mode flight mode Multirotor flight (remote position of the remote control gear switch M-MODE)
1. 多旋翼模式飞行模式 Multirotor flight (遥控器档位开关最上位置 M-MODE)

Throttle 油门

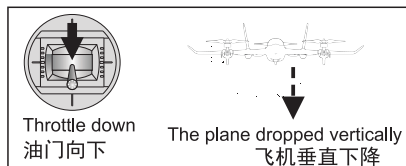
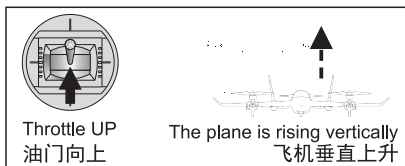

Rudder 方向

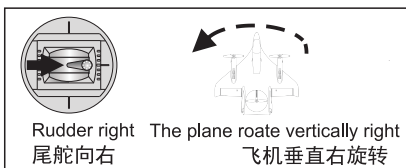
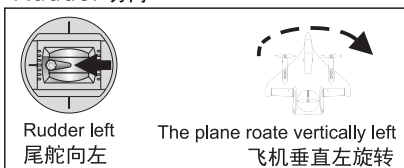

Elevator 升降

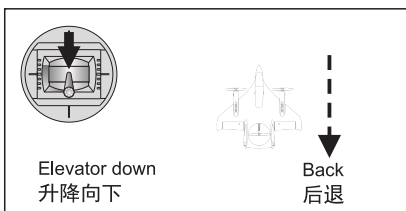
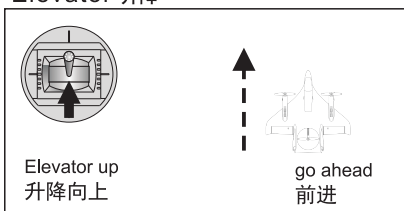

## Aileron 副翼

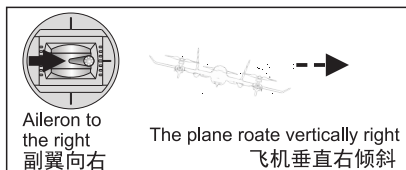
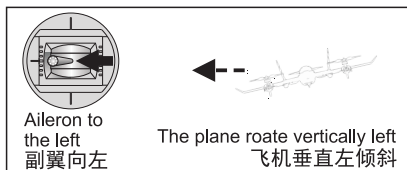

## 2. Horizontal mode operation method (remote position switch position 6G-MODE)

### 2. 水平模式操作方法 (遥控器档位开关中间位置6G-MODE)

## Rudder 方向

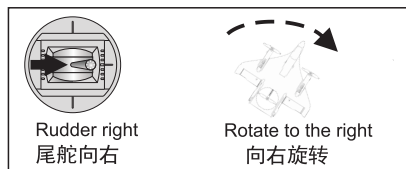
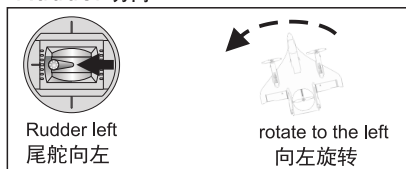

## Elevator 升降

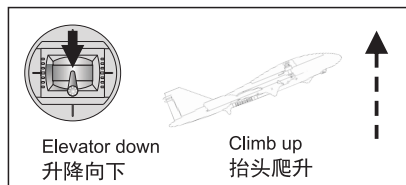
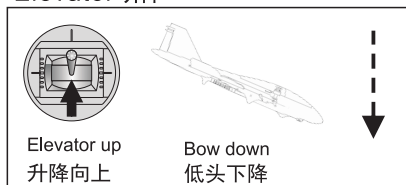

## Aileron 副翼

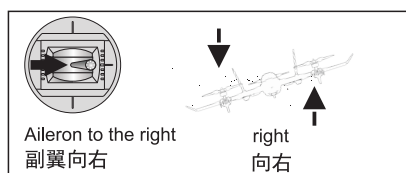
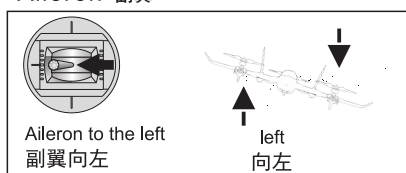

## 3. Vertical mode operation method

(V-MODE at the lowest position of the remote control position switch)

### 3. 垂直模式操作方法 (遥控器档位开关最下位置V-MODE)

## Throttle 油门

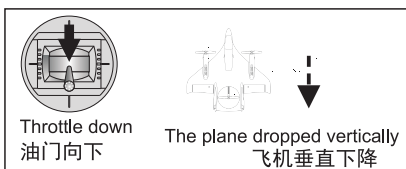
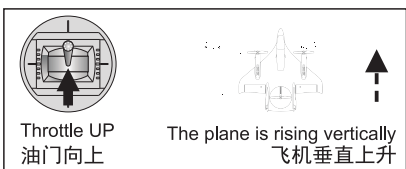

## Rudder 方向

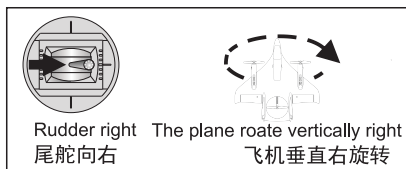
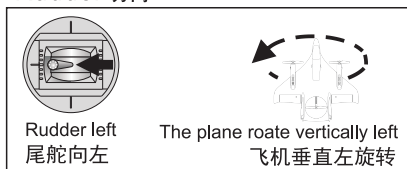

## Elevator 升降

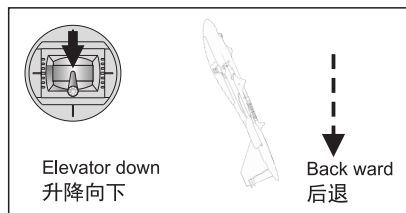
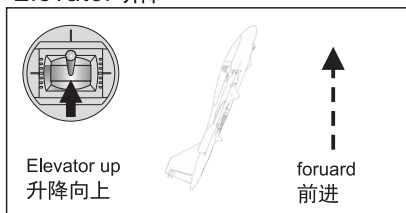

## Aileron 副翼

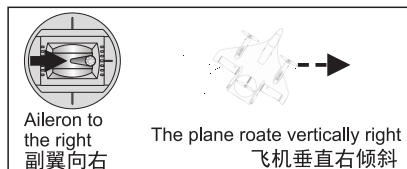
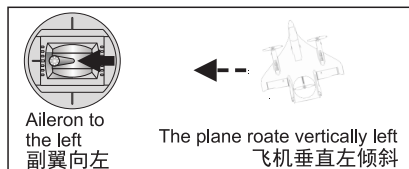

Special Note: 1 Before you understand the various modes of operation of the aircraft, please be sure to read the instructions carefully, be familiar with the over-control in all directions and repeat the practice.

2 There are two modes for level flight, beginners first please practice 6-axis mode, able to master the take-off and landing before the 3D mode.

3 3D mode Before flying simulator exercises, or ask professionals to guide the flight.

特别提示：1 您还没了解飞机各个动作操控方式前，请务必仔细阅读说明书，熟悉各个方向的超控并不断重复练习。

2 水平飞行有两种模式，初学者先练习6轴模式，能够熟练的掌握起飞和降落后再进行3D模式。

3 3D模式飞行前请先进行模拟器练习，或请专业人士进行指导飞行。

## Start your first flight 开始你的首次飞行

1. The binding of success of the flight level is placed on the ground, to ensure that the aircraft tail to you, head in front.

2. As the picture shows, Snai tme jog sticker corner to start/stop motors.

1. 将对频成功的飞行水平放置在地面上，确保飞机机尾对你，机头在前。

2. 如图示，同时将摇杆分别掰动在左下角和右下角，马达启动，再次如图示意掰摇杆则紧急关闭马达。

Note: After the aircraft landed on the ground, keep the throttle rocker in the lowest position for 2-3 seconds, then release the rocker after the airplane motor stops completely.

注意：飞行器降落地面后，需保持油门摇杆在最下位置2-3秒，飞机马达彻底停止转动后在松开摇杆。

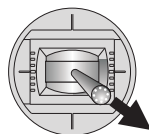
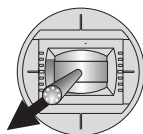

The aircraft can only take off vertically and vertically in the Multirotor flight. Make sure that the remote gear switch is in the M-MODE position before each flight, and the switch cannot unlock the flight in other positions.

该飞行器只能在Multirotor flight（四轴模式下）垂直起飞和垂直降落，每次飞行前请确保遥控档位开关在M-MODE位置，开关在其他位置则不能解锁飞行。

## Aircraft low battery alarm 飞行器低电报警

Two levels setted for low power protection

飞行器设置两级低电保护

The aircraft enters the level 1 protection power indicator light flashes quickly, the aircraft power is weakened, and the aircraft needs to fly to the visible range as soon as possible.

And ready to land.

The aircraft enters Class 2 protection and will land in place.

飞行器进入 1级保护电源指示灯快闪, 飞行器动力减弱, 需尽快将飞行器飞至可视范围内, 并准备降落。

飞行器进入 2级保护, 将原地降落。

Special note: Please pay special attention to the battery power when flying. When you feel that the battery is low, please landing drop the aircraft as soon as possible to avoid unnecessary loss.

特别备注: 飞行时请特别注意电池电量, 当感觉到电量不足时, 请尽快将飞行器降落, 以免造成不必要是损失

## One key take-off/one key landing 一键起飞/一键降落

1 One-key take-off / One-key landed required in vertical mode.

2 aircraft and remote control to complete the frequency, the aircraft placed vertically on the ground.

3 remote control throttle rocker in the middle position, press the TAKE OFF button for 2-3 seconds, after hearing the sound, press the button, the aircraft motor starts automatically, after 1-2 seconds the aircraft automatically take off about 1.5 meters high and Hover.

3 During the flight press TAKE OFF key for 2-3 seconds, the aircraft automatically landed vertically.

1 一键起飞/一键降落需在垂直模式下进行。

2 飞行器与遥控器对频完成, 将飞行器垂直摆放到地面上。

3 遥控器油门摇杆放在中间位置, 按TAKE OFF键2-3秒, 听到一声滴音后松开按键, 此时飞行器马达自动启动, 1-2秒后飞行器自动起飞1.5米左右高度并悬停。

3 飞行过程中长按TAKE OFF键2-3秒, 飞行器垂直自动降落。

Ground take off  
地面起飞



## Aircraft level calibration 飞行器水平校准

1) When the aircraft is obviously yawed, the flight attitude can be corrected by horizontal calibration.

2) As shown in the figure: the left and right joysticks are simultaneously moved to the lower left corner position for 1-2 seconds. At this time, the aircraft status indicator flashes rapidly, the aircraft enters the horizontal calibration, and the aircraft status indicator is keep on, and the horizontal calibration is successful.

1) 当飞行器出现明显偏航, 可通过水平校准校正飞行姿态。

2) 如图示: 将左右摇杆同时扳动到左下角位置1-2秒, 此时飞机状态指示灯出现快闪, 飞机进入水平校准, 待飞机状态指示灯常亮, 水平校准成功。

Special Note:

1. Calibration to find a relatively more level of venues, as far as possible to ensure that the aircraft and the ground level.

2. Aircraft into the level of calibration procedures, the need to keep the aircraft stationary, until the calibration was successful.

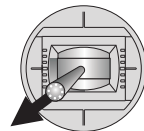
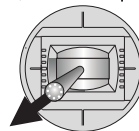

特别提示:

1. 校准需找相对比较水平的场地, 尽可能保证飞机与地面水平。

2. 飞机进入水平校准程序后, 需保持飞机静止不动, 至到校准成功。

## Circuit board schematic 电路板示意图

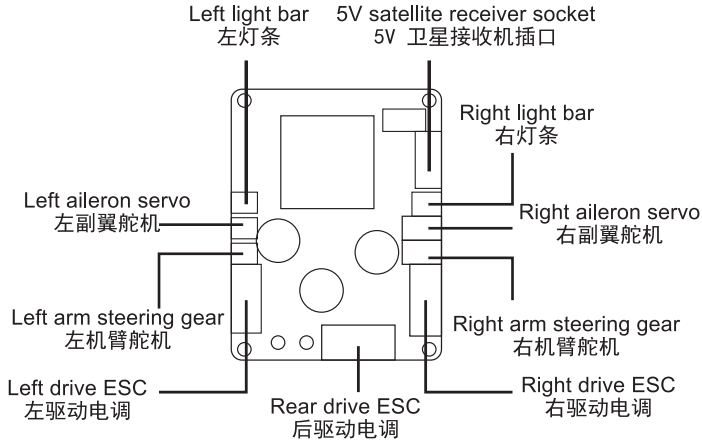

## How to troubleshoot anomalies in flight 排除故障及异常情

Situation 状况	Reason 原因	Countermeasure 对策
The plane no working and the signal indicator lights flash after battery connected. 飞机上电后信号灯闪动，操作无反应	Remote control binding failed 遥控器与飞机对码绑定不成功	Re-binding according page  按第6页内的温馨提醒中的对码绑定步骤重新对码
Gyroscope start working, before the plane was connected with battery and the motor was no activated. 飞机上电后未启动马达陀螺仪就开始工作	The throttle jogsticker is not in the lowest position or throttle trim is too high wher power on 飞机上电时油门摇杆未在最下位置或油门微调过高	Pull throttle jogsticker in the correct position, power on again after the throttle trim is back to the midpoint 将油门摇杆放到正确位置，将油门微调回到中点后重新上电
The signal indicator and the servo works OK after power on, the throttle not working when pushing. 飞机上电后推动油门不转，信号灯正常舵机工作正常	Not enough power, ESC enter the power-off protection.  电池电量过低，调速器进入关断保护	Charge the battery or replace the charged battery 将电池充电或更换有电的电池

<p>Push the throttle but motor does not start, motor is reversing 推动油门后马达未正常启动，马达在不停换向</p>	<p>Poor contact between motor and speed controller, motor break down 马达与调速器接触不良或马达出现故障</p>	<p>Connect motor plug or replace the motor 将马达插头进行连接或更换马达</p>
<p>Individual rudder servo block when manipulating the joystick 摇杆操纵时个别舵机出现卡舵现象</p>	<p>Motor vibrates a lot when it works 舵机齿轮出现少齿</p>	<p>Replace servo 更换有问题的舵机</p>
<p>Abnormal motors vibration 马达运转时震动的很厉害</p>	<p>Blade deformation, untight position between hoop and motor, or hoop broken, motor seat loose 桨叶变形，桨箍与马达定位不牢或桨箍断裂，马达固定座松脱</p>	<p>Replace the faulty blades and hoop, fix hoop firmly, fix the motor fixed seat 更换有问题的桨叶及桨箍，将桨箍固定牢固，将马达固定座固定</p>
<p>Model yaw fly, can not fly straight 模型飞起来偏航，不能直线飞行</p>	<p>Rudder is not in the center position, gyroscope accumulated error is big 舵面没有在居中位置，陀螺仪累计误差大</p>	<p>1. Turn the rudder back to center 2. Gyroscope be reset to 0 and adjusted according to Page 9 1.将舵面回中 2.按第9页中的陀螺仪清零校准</p>
<p>Plane fly but gyroscope has no reaction, can not repair angle normally 飞机飞起来陀螺仪无动作，不能正常修复角度</p>	<p>Gyroscope is out of control 陀螺仪失灵</p>	<p>Replace the receiver 更换接收机</p>
<p>Landing, or roll the throttle at the lowest position, the motor is still running 飞机降落，或油门摇在最下位置，马达仍在运转</p>	<p>During flight, mistakenly raised throttle trim 飞行中误将油门微调调高</p>	<p>Turn the throttle trim back to the mid-point 将油门微调调回中点</p>





Email: [sales@xk-innovations.com](mailto:sales@xk-innovations.com)